



Description	4
Product Assembly	5
Devices raised mounting	6
Accessories.....	8
Technical Data.....	13
Typical Applications	16
Marking	18
Drawings.....	19
Index.....	28

Product Information

General notes

The series 31 illuminated pushbuttons are equipped with snap-action or low-level switching elements.

Besides the standard contacts (gold-plated silver) silver contacts for switching elements 2.8 mm plug-in terminals can be supplied on request.

The front dimensions of these units are 18 x 24 mm, 18 x 18 mm or 18 mm dia.

In addition to a number of illuminated pushbuttons, the customer can choose from a range of other units and accessories having the same front and mounting dimensions: Indicators, Flashers, Buzzers, etc. (For keylock switches see series 51 or 61.)

Mounting

All switch actuators are mounted from the front by pushing them through the mounting hole in the front panel. They are then fixed from the back with a fixing nut and the mounting tool Typ-Nr. 01-907. Max. tightening torque 50 Ncm.

For switching elements with 2.8 mm plug-in terminals, we offer plug-in bases, which when soldered to a PCB enable a plug-in connection to the button. The rectangular actuators are provided with an anti-twisting device.

Lenses

The flat or concave lenses, made of Polymethyl Methacrylate, are available in various colours, as well as translucent or transparent.

Marking

For further information about engraving, hot stamping and film inserts see part Marking.

Illumination

The T1 ³/₄ Midget Groove incandescent (filament) lamp (6 ... 48 V) ensures perfect illumination of the lenses, which are supplied in various colours.

T1 ³/₄ Midget Groove Single-LED (6, 12, 24, 28, 48 V) are also available in blue, green, red, white or yellow.

Luminosity and wave length scattering caused by the technology used in the LED manufacturing processes may lead to visual differences in our products.

For supply voltages above 48 V, it is necessary to use a voltage reduction element (external series resistor or transformer).

Position indication

The status of a maintained action switch can be determined by the position of the lens.

Specimen order

Indicator :

- | | |
|--|------------|
| - Indicator actuator, 18 x 24 mm, soldering terminal | 31-040.005 |
|--|------------|

Essential accessories :

- | | |
|--|--------------|
| - Lens plastic blue, transparent, flush, 18 x 24 mm | 31-903.6 |
| - Single-LED, T1 ³ / ₄ MG, 24 VAC/DC, blau | 10-2J12.1066 |

*We reserve the right to modify technical data
All dimensions in mm*

Pushbutton illuminative, raised mounting

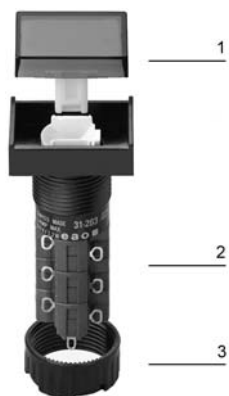



- 1 Lens
- 2 Switch housing
- 3 Fixing nut

Indicator actuator



Essential Accessories:

-  Lens plastic page 8
-  Single-LED page 11

	Front protection	Diode (1N 4007)	Terminals	□ 18 x 18 mm Typ-Nr.	□ 18 x 24 mm Typ-Nr.	∅ 18 mm Typ-Nr.	Component layout	Mounting dimensions	Technical drawing	Circuit drawing	
Indicator actuator	IP 40	1 D	UT	31-703.006	31-701.006		4	1	3	33	0.006
		2 D	UT	31-704.006	31-702.006		4	1	3	34	0.006
	-	S		31-050.005	31-040.005	31-030.005		1	10	4	0.004
		S1		31-050.002	31-040.002	31-030.002		1	10	3	0.004
		UT		31-051.006	31-041.006	31-031.006	4	1	3	3	0.005

Diode (1N 4007): D = Diode, - = without

Terminals: UT = Universal terminal, S = Soldering terminal, S1 = Soldering terminal (also pluggable 2.8 x 0.5 mm)

Component layout from page 19, Mounting dimensions from page 20, Technical drawing from page 20, Circuit drawing from page 22

Buzzer



	Front protection	Front cap	Terminals	□ 18 x 24 mm Typ-Nr.	Mounting dimensions	Technical drawing	Circuit drawing	
Buzzer Operation voltage : 10 ... 26 VDC	IP 40	Plastic black	S1	31-801.002	1	4	1	0.015
Operation voltage : 10 ... 55 VAC, 10 ... 75 VDC	IP 40	Plastic black	S	31-810.005	1	5	2	0.015

Further information in the Technical Data and Typical Applications

Terminals: S1 = Soldering terminal (also pluggable 2.8 x 0.5 mm), S = Soldering terminal

Mounting dimensions from page 20, Technical drawing from page 20, Circuit drawing from page 22

Illuminated pushbutton actuator



Essential Accessories:

- Lens plastic page 8
- Single-LED page 11

	Front protection	Switching system	Contacts	Diode (1N 4007)	Switching action	Terminals	Ø 18 x 18 mm Typ-Nr.	Ø 18 x 24 mm Typ-Nr.	Ø 18 mm Typ-Nr.	Component layout	Mounting dimensions	Technical drawing	Circuit drawing		
Illuminated pushbutton actuator	IP 40	LL	1 NC	-	MA	UT	31-486.036	31-466.036	31-476.036	4	1	3	14	0.007	
					M	UT	31-456.036	31-426.036	31-436.036	4	1	3	28	0.007	
			1 NC + 1 NO	-	MA	UT	31-483.036	31-463.036	31-473.036	4	1	3	17	0.007	
					M	UT	31-453.036	31-423.036	31-433.036	4	1	3	31	0.007	
			1 NO	-	MA	UT	31-485.036	31-465.036	31-475.036	4	1	3	16	0.007	
					M	UT	31-455.036	31-425.036	31-435.036	4	1	3	30	0.007	
			2 NC	-	MA	UT	31-482.036	31-462.036	31-472.036	4	1	3	15	0.007	
					M	UT	31-452.036	31-422.036	31-432.036	4	1	3	29	0.007	
			2 NO	-	MA	UT	31-481.036	31-461.036	31-471.036	4	1	3	18	0.007	
					M	UT	31-451.036	31-421.036	31-431.036	4	1	3	32	0.007	
			SA	1 NC + 1 NO	1 D	MA	UT	31-717.0292	31-713.0292	31-747.0292	4	1	11	11	0.008
						M	UT	31-709.0292	31-705.0292	31-743.0292	4	1	11	25	0.008
					2 D	MA	UT	31-718.0292	31-714.0292	31-748.0292	4	1	11	12	0.008
						M	UT	31-710.0292	31-706.0292	31-744.0292	4	1	11	26	0.008
					-	MA	S	31-281.0252	31-261.0252	31-271.0252		1	9	13	0.006
							S1	31-281.022	31-261.022	31-271.022		1	9	10	0.006
		M				S	31-151.0252	31-121.0252	31-131.0252		1	9	27	0.006	
						S1	31-151.022	31-121.022	31-131.022		1	9	24	0.006	
		2 NC + 2 NO			1 D	MA	UT	31-719.0292	31-715.0292	31-749.0292	4	1	11	7	0.010
						M	UT	31-711.0292	31-707.0292	31-745.0292	4	1	11	21	0.010
					2 D	MA	UT	31-720.0292	31-716.0292	31-750.0292	4	1	11	8	0.010
						M	UT	31-712.0292	31-708.0292	31-746.0292	4	1	11	22	0.010
					-	MA	S	31-282.0252	31-262.0252	31-272.0252		1	9	9	0.008
						M	S	31-152.0252	31-122.0252	31-132.0252		1	9	23	0.008
		3 NC + 3 NO			-	MA	S	31-283.0252	31-263.0252	31-273.0252		1	9	6	0.010
						M	S	31-153.0252	31-123.0252	31-133.0252		1	9	20	0.010
		4 NC + 4 NO	-	MA	S	31-284.0252	31-264.0252	31-274.0252		1	9	5	0.012		
				M	S	31-154.0252	31-124.0252	31-134.0252		1	9	19	0.012		

Power rating: Low level switching element 42 V, 100 mA; Snap action switching element 250 V, 5 A

Switching system: LL = Low level switching element, SA = Snap-action switching element

Contacts: NC = Normally closed, NO = Normally open

Diode (1N 4007): - = without, D = Diode

Switching action: MA = Maintained action, M = Momentary action

Terminals: UT = Universal terminal, S = Soldering terminal, S1 = Soldering terminal (also pluggable 2.8 x 0.5 mm)

Component layout from page 19, Mounting dimensions from page 20, Technical drawing from page 20, Circuit drawing from page 22

Front

Lens plastic

	Lens	∅ 18 x 18 mm Typ-Nr.	∅ 18 x 24 mm Typ-Nr.	∅ 18 mm Typ-Nr.	
Lens plastic concave, illuminative	blue transparent	31-954.6	31-904.6		0.001
	colourless transparent	31-954.7	31-904.7		0.001
	green transparent	31-954.5	31-904.5		0.001
	orange transparent	31-954.3	31-904.3		0.001
	red transparent	31-954.2	31-904.2		0.001
	yellow transparent	31-954.4	31-904.4		0.001
concave, non-illuminative	black opaque	31-952.0	31-902.0		0.001
	grey opaque		31-902.8		0.001
flush, illuminative	blue transparent	31-953.6	31-903.6	31-933.6	0.001
	colourless transparent	31-953.7	31-903.7	31-933.7	0.001
	green transparent	31-953.5	31-903.5	31-933.5	0.001
	orange transparent	31-953.3	31-903.3	31-933.3	0.001
	red transparent	31-953.2	31-903.2	31-933.2	0.001
	smoked transparent	31-953.1	31-903.1	31-933.1	0.001
	yellow transparent	31-953.4	31-903.4	31-933.4	0.001
	flush, illuminative (not recommended for film insert)	blue translucent	31-951.6	31-901.6	31-931.6
	colourless transparent	31-955.7	31-905.7	31-935.7	0.001
	green translucent	31-951.5	31-901.5	31-931.5	0.001
	green transparent	31-955.5	31-905.5	31-935.5	0.001
	orange translucent	31-951.3	31-901.3	31-931.3	0.001
	red translucent	31-951.2	31-901.2	31-931.2	0.001
	red transparent	31-955.2	31-905.2	31-935.2	0.001
	white translucent	31-951.9	31-901.9	31-931.9	0.001
	yellow translucent	31-951.4	31-901.4	31-931.4	0.001
	yellow transparent	31-955.4	31-905.4	31-935.4	0.001
flush, non-illuminative	black opaque	31-951.0	31-901.0	31-931.0	0.001
	grey opaque	31-951.8	31-901.8	31-931.8	0.001
concave, non-illuminative	grey opaque		31-902.8		0.001



Protective cover

	∅ 18 x 18 mm Typ-Nr.	∅ 18 x 24 mm Typ-Nr.	Technical drawing	
Protective cover hinged, transparent, with means for sealing	31-920		7	0.002
		31-925	8	0.002



Technical drawing from page 20

Front protective cap

front protection IP 67

		Ø 18 x 18 mm Typ-Nr.	Ø 18 x 24 mm Typ-Nr.	Mounting dimensions	Technical drawing	kg
Front protective cap						
Front protective cap two-part	PVC	31-923		2	6	0.003
	Silikon		31-924.2	2	6	0.003



Mounting dimensions from page 20, Technical drawing from page 20

Protective guard

matt chromium-plated

		Typ-Nr.	Technical drawing	kg
Protective guard broad sides bent upwards		01-927	2	0.011
narrow ends bent upwards		01-926	1	0.011



Technical drawing from page 20

Blind plug

		Ø 18 x 18 mm Typ-Nr.	Ø 18 x 24 mm Typ-Nr.	Ø 18 mm Typ-Nr.	Mounting dimensions	kg
Blind plug						
Blind plug	Plastic black	01-948.0	01-947.0	01-949.0	1	0.001



Mounting dimensions from page 20

Backside

PCB plug-in base

	Terminals	Typ-Nr.	Component layout	
PCB plug-in base 16.4 mm dia. x 9.8 mm for Low level switching element, Pins axial	P	31-940	1	0.002
17.8 x 12.9 mm x 9.8 mm for Snap-action switching element 2.8 mm, Pins axial	P	31-942	3	0.002
17.9 x 17.9 x 8.4 mm for Low level switching element, Pins bent at right-angle	P	31-941	2	0.004



PCB plug-in base Pins right-angle : With the extendable mounting the distance between plug-in base and PCB can be varied up to 3 mm

Terminals: P = PCB terminal

Component layout from page 19

Flat receptacle

	Typ-Nr.	
Flat receptacle 2.0 x 0.5 mm for Universal terminal	31-945	0.001
2.8 x 0.5 mm for Plug-in terminal	31-946	0.001



Insulation sleeve

	Typ-Nr.	
Insulation sleeve Cover Plug-in terminals for snap-action switching element 2.8 mm	01-928	0.001
for Flat receptacle 31-945	31-928	0.001
for Flat receptacle 31-946	31-929	0.001



Terminal cover

	Typ-Nr.	
Terminal cover	01-929	0.010



Illumination

Filament lamp

	Socket	Operating voltage/-current	Typ-Nr.	
Filament lamp	T1 3/4 MG	12 VAC/DC, 75 mA	10-1309.1309	0.001
		14 VAC/DC, 80 mA	10-1310.1319	0.001
		18 VAC/DC, 40 mA	10-1311.1249	0.001
		24 VAC/DC, 35 mA	10-1312.1229	0.001
		28 VAC/DC, 30 mA	10-1313.1209	0.001
		28 VAC/DC, 40 mA	10-1313.1249	0.001
		36 VAC/DC, 20 mA	10-1316.1179	0.001
		36 VAC/DC, 30 mA	10-1316.1209	0.001
		48 VAC/DC, 20 mA	10-1319.1179	0.001
		48 VAC/DC, 25 mA	10-1319.1199	0.001
		6 VAC/DC, 120 mA	10-1306.1349	0.001
		6.3 VAC/DC, 200 mA	10-1307.1369	0.001



Single-LED

	Socket	Light colour	Operating voltage/-current	Typ-Nr.	
Single-LED	T1 3/4 MG	blue	12 VAC/DC, 7/14 mA	10-2J09.1066	0.002
			24 VAC/DC, 7/14 mA	10-2J12.1066	0.002
			28 VAC/DC, 7/14 mA	10-2J13.1066	0.002
			48 VAC/DC, 4/8 mA	10-2J19.1046	0.002
			6 VDC, 15 mA	10-2J06.3146	0.002
		green	12 VAC/DC, 4/7 mA	10-2J09.1065	0.002
			24 VAC/DC, 4/7 mA	10-2J12.1065	0.002
			28 VAC/DC, 4/7 mA	10-2J13.1065	0.002
			48 VAC/DC, 2/4 mA	10-2J19.1045	0.002
			6 VDC, 7 mA	10-2J06.3145	0.002
		red	12 VAC/DC, 7/14 mA	10-2J09.1062	0.002
			24 VAC/DC, 7/14 mA	10-2J12.1062	0.002
			28 VAC/DC, 7/14 mA	10-2J13.1062	0.002
			48 VAC/DC, 4/8 mA	10-2J19.1042	0.002
			6 VDC, 15 mA	10-2J06.3142	0.002
		white diffuse	12 VAC/DC, 7/14 mA	10-2J09.1069	0.002
			24 VAC/DC, 7/14 mA	10-2J12.1069	0.002
			28 VAC/DC, 7/14 mA	10-2J13.1069	0.002
			48 VAC/DC, 4/8 mA	10-2J19.1049	0.002
			6 VDC, 15 mA	10-2J06.3149	0.002
		yellow	12 VAC/DC, 7/14 mA	10-2J09.1064	0.002
			24 VAC/DC, 7/14 mA	10-2J12.1064	0.002
			28 VAC/DC, 7/14 mA	10-2J13.1064	0.002
			48 VAC/DC, 4/8 mA	10-2J19.1044	0.002
			6 VDC, 15 mA	10-2J06.3144	0.002



Note:
AC operation through halve-wave rectifier possible, slight flickering can occur.

Series resistor

for lamp voltage reduction

	Operation voltage	Typ-Nr.	
Series resistor 10 kΩ, for filament lamp 48 VAC, 25 mA	230/240 V	02-904.7	0.003
2.7 kΩ, for filament lamp 48 VAC, 25 mA	110 V	02-904.0	0.003
3.3 kΩ, for filament lamp 48 VAC, 25 mA	125 V	02-904.1	0.003
4.7 kΩ, for filament lamp 48 VAC, 25 mA	145 V	02-904.3	0.003



Please keep to the country specific security rules.

Terminal plate empty

for fitting with series resistors

	Typ-Nr.	
Terminal plate empty 10 spaces 125 x 60 x 15 mm	02-912.2	0.045
15 spaces 187.5 x 60 x 15 mm	02-912.3	0.090
5 spaces 62.5 x 60 x 15 mm	02-912.1	0.025



Assembling

Lens remover

	Typ-Nr.	
Lens remover	02-905	0.011



Lamp remover

	Typ-Nr.	
Lamp remover	61-9740.0	0.003



CAUTION

A switching process might be released when replacing the lamp/LED !

Mounting tool

	Typ-Nr.	
Mounting tool for Indicator 16 mm dia.	01-907	0.020



Dressing tool

for aligning buttons

	Typ-Nr.	
Dressing tool	01-906	0.030



Actuator with snap-action switching element

Switching system

Self-cleaning, double-break, snap action switching system (with contact gap 2 x 0.5 mm).
 1 Normally closed or 1 Normally open contact per element.
 Snap-action switching elements with soldering terminals at the sides: Up to 4 switching element can be on a pushbutton (max. 4 Normally closed and 4 Normally open contacts).
 Snap-action switching element with axial plug-in terminals 2.8 mm stachable, only 1 switching element can be on a pushbutton.

Material

Material of contact

Gold plated silver

Switch housing

Axial plug-in-/soldering terminal 2.8 mm:
 Diallylphthalate (DAP), Polyamide (PA66), Polysulfone, heat-resistant and self-extinguishing
 Soldering terminal: PA 6.6 Ultramide

Actuator housing

Polyetherimide, self-extinguishing

Mechanical characteristics

Terminals

Snap-action switching element with tinned soldering terminals at the sides:
 Max. wire diameter 2 wires à 1.2 mm
 Max. wire cross-section of stranded cable 1 x 1 mm²
 Snap-action switching element with axial plug-in terminals, which can also be used as soldering terminals: Plug-in terminal 2.8 x 0.5 mm

Soldering terminal:

Max. wire diameter 1 wire of 1.5 mm²
 Max. wire cross-section of stranded cable 2 x 0.75 mm² or 1 x 1.0 mm²

Actuating force

2 N ... 5.5 N, depending on the number of switching elements

Actuating travel

3 mm

Rebound time

≤5ms

Mechanical lifetime

Momentary action 2 million cycles of operation
 Maintained action 1 million cycles of operation

Electrical characteristics

Standards

IEC 61058, EN 61058

Rated voltage

250 VAC/VDC

Rated current

5 A

Contact resistance

Starting value (initial) ≤50 mΩ

Conventional free air thermal current

5 A

The maximum current in continuous operation and at ambient temperature not exceeding the quoted maximum values.

Switch rating

250 VAC, 5 A (cosφ 1)
 250 VAC, 3 A (cosφ 0,3)

Switch rating AC (cosφ 0,7)

Voltage	125 VAC	250 VAC
Current	3 A	2 A

Switch rating DC (inductive) L:R = 30 ms

Voltage	24 VDC	60 VDC	110 VDC	220 VDC
Current	2 A	0.7 A	0.2 A	0.1 A

Electric strength

2500 VAC, 50 Hz, 1 min. between all terminals and earth, as per IEC 60512-2-11

Protection class

II

Environmental conditions

Storage temperature

-40 °C ... +85 °C

Service temperature

-25 °C ... +55 °C

For indicators and illuminated pushbuttons mounted as a block, make sure the heat can escape freely.

Protection degree

Front as per:
 IP 40
 IP 65 with spray cover

Shock resistance

(Single impacts, semi-sinusoidal)
 15 g for 11 ms, as per IEC 60512-4-3, IEC 60068-2-27

Vibration resistance

(sinusoidal)
 10 g at 0-2000 Hz, amplitude 1.5 mm, as per IEC 60512-4-4, IEC 60068-2-6

Climate resistance

Standard condition, as per IEC 60068-2-3 and 2-30
 Changing condition, as per IEC 60068-2-14 and 2-33

Approvals

Approbations

CB (IEC 61058)
 CSA
 ENEC (EN 61058)
 Germanischer Lloyd
 UL

Declaration of conformity

CE
 RoHS

Actuator with low level switching element

Switching system

This low level switching element was designed for switching low powers in electronic circuits. The mechanism assures reliable switching of loads ranging from a few $\mu\text{A}/\mu\text{V}$ up to 100 mA/42 VAC/DC.

Single-break momentary contact, as normally open or normally closed with 4 independent points of contact. 2 momentary contacts per switching element; combination of normally open and normally closed is possible.

Special features are the long life, extremely short rebound time and stable contact resistance.

Material

Material of contact

Gold plated

Switch housing

Polysulfone, heat-resistant and self-extinguishing

Actuator housing

Polyetherimide, self-extinguishing

Mechanical characteristics

Terminals

The universal terminals permit these units to be mounted on printed circuit boards (PCB). These terminals can also be used as soldering or plug-in terminals.

For these terminals we can also supply a plug-in base which, when soldered on to the board, enables the switch to be plugged in.

Soldering terminal:

Max. wire diameter 2 wires ≈ 0.8 mm

Max. wire cross-section of stranded cable 1×0.75 mm²

Plug-in terminal: 2.0 x 0.5 mm

Actuating force

3 N ... 3,5 N

Actuating travel

3 mm

Rebound time

Typ. <100 μs

Mechanical lifetime

Momentary action 5 million cycles of operation

Maintained action 1 million cycles of operation

Electrical characteristics

Standards

EN 61058

Contact resistance

Starting value (initial) ≤ 50 m Ω

Switch rating

10 μA , 100 μV to 100 mA at 42 VAC/VDC

Electric strength

2500 VAC, 50 Hz, 1 min. between all terminals and earth, as per IEC 60512-2-11

Protection class

II

Environmental conditions

Storage temperature

-40 °C ... +85 °C

Service temperature

-25 °C ... +55 °C

For indicators and illuminated pushbuttons mounted as a block, make sure the heat can escape freely.

Protection degree

Front as per:

IP 40

IP 65 with spray cover

Shock resistance

(Single impacts, semi-sinusoidal)

15 g for 11 ms, as per IEC 60512-4-3, IEC 60068-2-27

Vibration resistance

(sinusoidal)

10 g at 0-2000 Hz, amplitude 1.5 mm, as per IEC 60512-4-4, IEC 60068-2-6

Climate resistance

Standard condition, as per IEC 60068-2-3 and 2-30

Changing condition, as per IEC 60068-2-14 and 2-33

Buzzer Typ-Nr. 31-810.005

Switching system

Buzzer system

Electronic non-contacting buzzer
with IC oscillator

Material

Alarm buzzer case

Polyetherimide

Front bezel

Polyamide

Mechanical characteristics

Terminals

Soldering terminal

Electrical characteristics

Frequency (tone)

Approx. 2.8 kHz

Interval frequency

approx. 3 Hz

Sound pressure

88 dB (A) ± 8 dB at a distance of 0.1 m
Volume variable with a 1 M Ω potentiometer or corresponding fixed resistor

Operation Voltage/Current

Typ. 10 VAC ... 55 VAC, 25 mA
Typ. 10 VDC ... 75 VDC, 15 mA

Environmental conditions

Storage temperature

-40 °C ... +85 °C

Service temperature

-25 °C ... +55 °C

Protection degree

IP 40

Approvals

Approbations

Germanischer Lloyd

Declaration of conformity

CE
RoHS

Buzzer Typ-Nr. 31-801.002

Switching system

Buzzer system

Electronic non-contacting buzzer
with IC oscillator

Material

Alarm buzzer case

Polyetherimide

Front bezel

Polyamide

Mechanical characteristics

Terminals

Plug-in terminal 2.8 x 0.5 mm

Electrical characteristics

Frequency (tone)

ca. 2.0 kHz

Interval frequency

2 Hz

Sound pressure

88 dB (A) ± 8 dB at a distance of 0.1 m

Operation Voltage/Current

10 VDC ... 26 VDC, ≤ 20 mA

Environmental conditions

Storage temperature

-40 °C ... +85 °C

Service temperature

-25 °C ... +55 °C

Protection degree

IP 40

Approvals

Approbations

Germanischer Lloyd

Declaration of conformity

CE
RoHS

Diode element

When indicators and illuminated pushbuttons equipped with diodes, the user is able to perform a lamp check or wire an alarm circuit simply with a considerable saving of space.

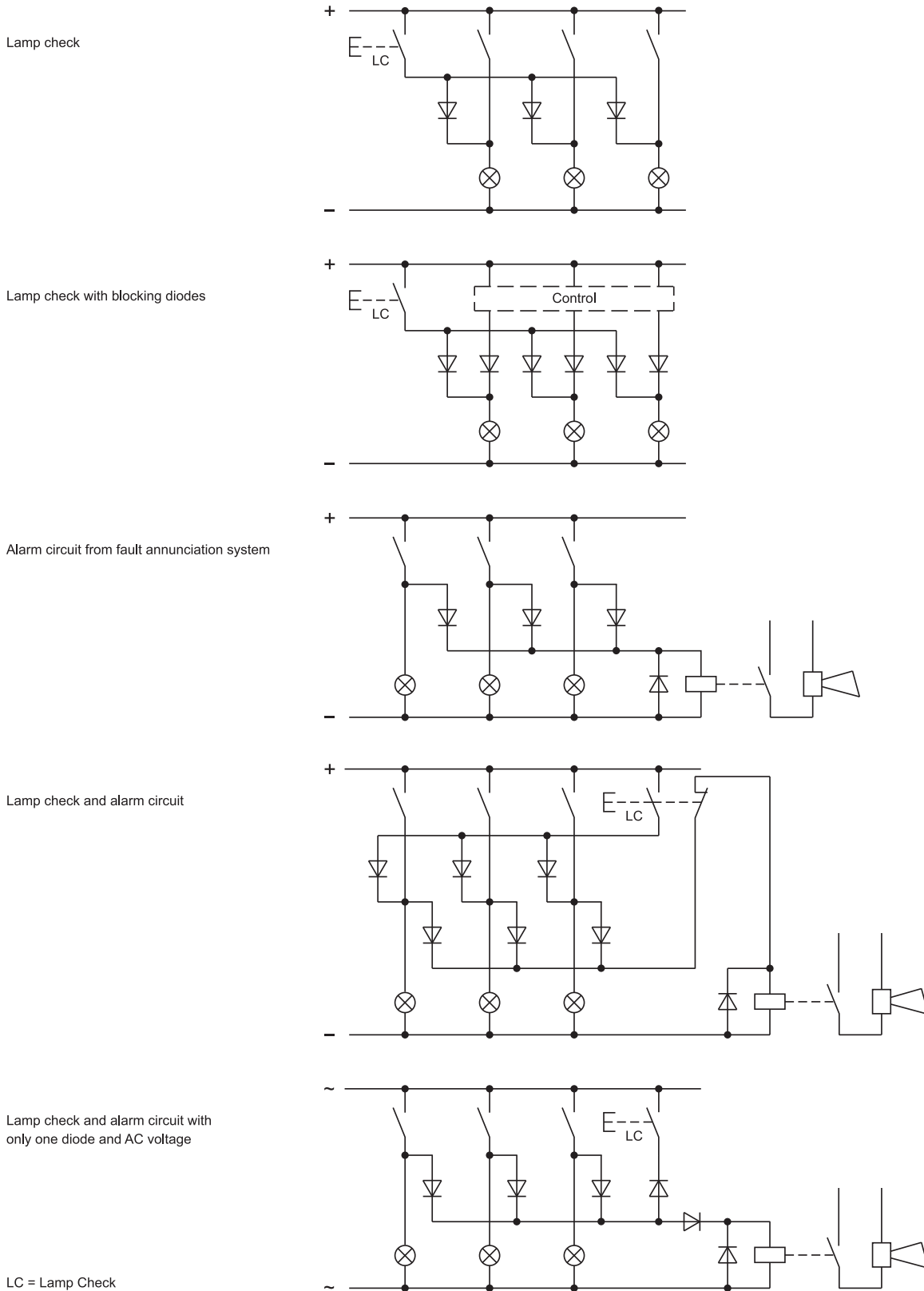

Buzzer (31-801.002)

Depending on how terminals are connected, the buzzer can operate with a continuous tone a(-) b(+) or with intermittent tone a(+) b(-).

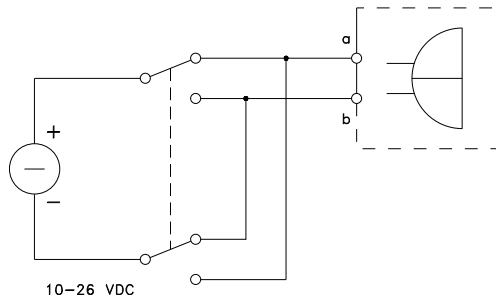

Buzzer (31-810.005)

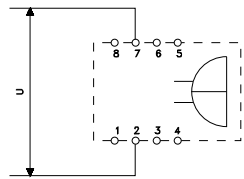

1. Supply voltage I
continuous tone
U = 10-35 VAC
U = 10-50 VDC

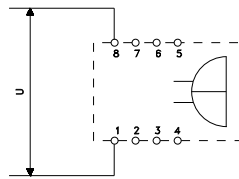

2. Supply voltage II
Continuous tone
U = 35-55 VAC
U = 35-75 VDC

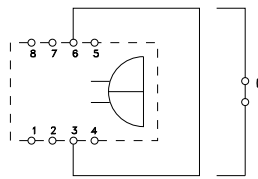

3. Intermittent tone
Interval apr. 3 Hz

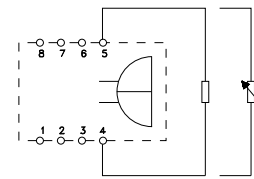

4. Volume control

General notes

1. Engraving

In addition to the most commonly used world languages, in DIN 1451-3 close spacing, other typefaces are available as Scandinavian, Slavic, Greek, Russian and Polish. Red, blue and black lenses are filled with white colour. Other colour lenses are filled in black.

2. Hot stamping

For larger series it is worth considering markings by means of hot stamping. We will be pleased to advise you. For letters and figures, typefaces with 2.5 mm, 3 mm and 4 mm are available.

3. Film inserts

Instead of using engraving the lenses can be fitted with transparent film inserts, as an alternative. For this purpose, though, it is advisable to use transparent lenses. In the case of use of a smoke-black lens the fitted film becomes readable only if the lamp is on.

To insert the film, the feet of the lens holder have to be pushed together far enough to enable the lens to be lifted off easily.

The film thickness is 0.2 mm.

Important : Consider pushbutton mounting orientation before specifying engraving characters !

All dimensions in mm

Film insert max. size	Height of letters h	Number of lines	Number of (target value) capital letters per line	Number of (target value) small letters per line	Image
12.7 x 18.7	2.5	4	11	12	B1
		5	7 - 8	8	B2
12.7 x 12.7	2.5	4	7 - 8	8	B3
Ø 12.8	2.5	3	6	6	B4
12.7 x 18.7	3.0	3	9 - 10	10 - 11	B1
		4	6 - 7	7	B2
12.7 x 12.7	3.0	3	6 - 7	7	B3
Ø 12.8	3.0	2	5	6	B4
12.7 x 18.7	4.0	2	7	7 - 8	B1
		3	4 - 5	5	B2
12.7 x 12.7	4.0	2	4 - 5	5	B3
Ø 12.8	4.0	2	3	4	B4
12.7 x 18.7	5.0	2	5 - 6	6	B1
			3 - 4	4	B2
12.7 x 12.7	5.0	2	3 - 4	4	B3
Ø 12.8	5.0	1	2	3	B4
12.7 x 18.7	6.0	1	4 - 5	5	B1
		2	3	3 - 4	B2
12.7 x 12.7	6.0	1	3	3 - 4	B3
Ø 12.8	6.0	1	2	2	B4
12.7 x 18.7	8.0	1	3 - 4	3 - 4	B1
12.7 x 18.7			2 - 3	2 - 3	B2
12.7 x 12.7	8.0	1	2 - 3	2 - 3	B3
Ø 12.8	8.0	1	2	2	B4

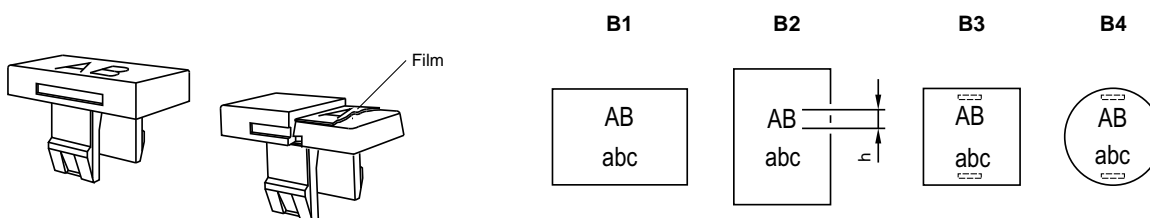

Component layout

1 PCB plug-in base page 10

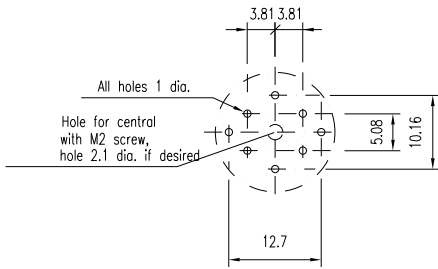

2 PCB plug-in base page 10

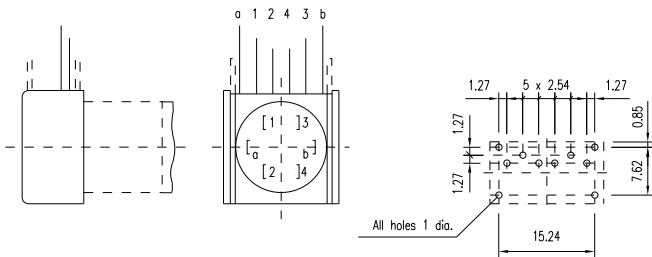

3 PCB plug-in base page 10

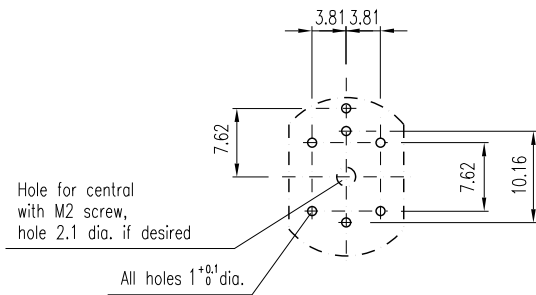

4 Indicator actuator page 6 | Illuminated pushbutton actuator page 7

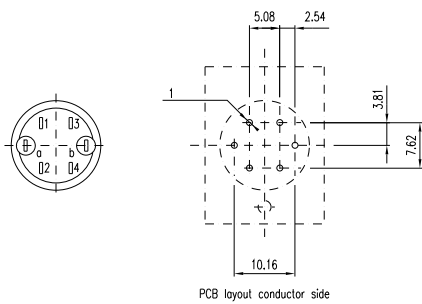

Mounting dimensions

1 Indicator actuator page 6 | Buzzer page 6 | Illuminated pushbutton actuator page 7 | Blind plug page 9

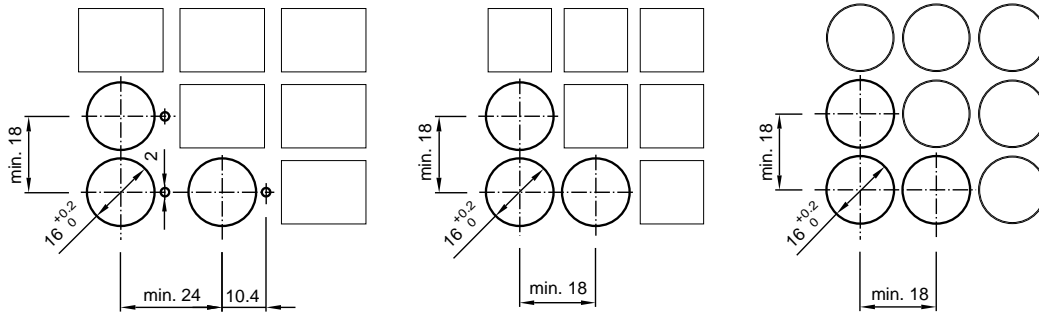

2 Front protective cap page 9

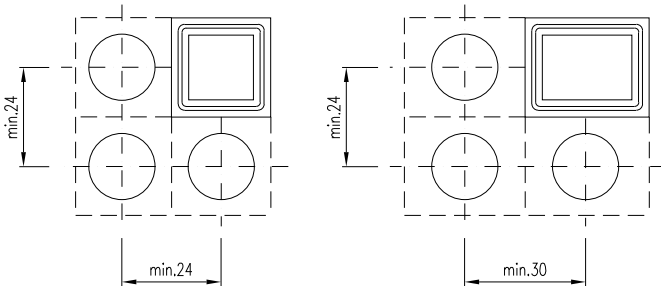

Technical drawing

1 Protective guard page 9

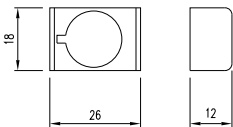

2 Protective guard page 9

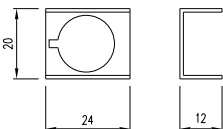

3 Indicator actuator page 6 | Illuminated pushbutton actuator page 7

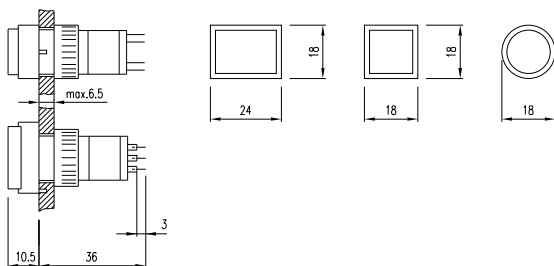

4 Buzzer page 6

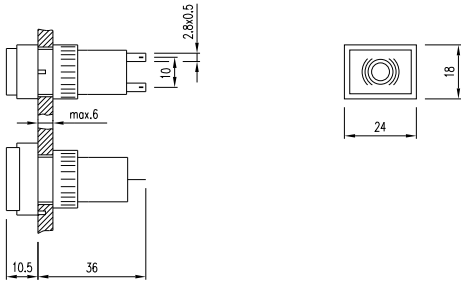

5 Buzzer page 6

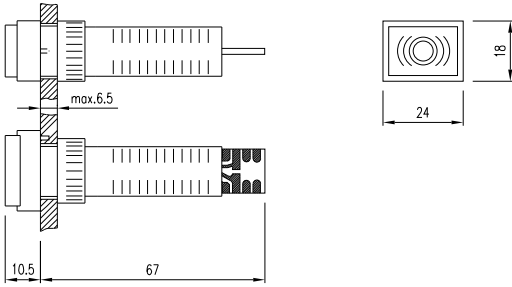

6 Front protective cap page 9

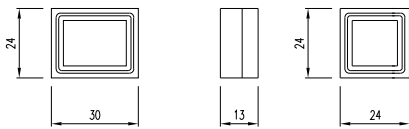

7 Protective cover page 8

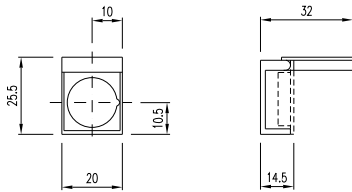

8 Protective cover page 8

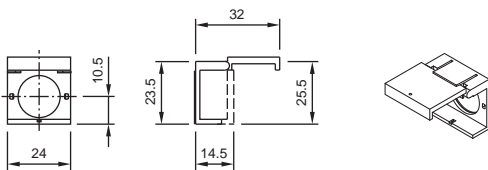

9 Illuminated pushbutton actuator page 7

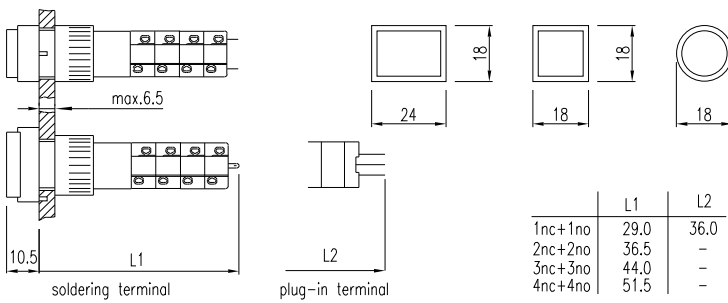

10 Indicator actuator page 6

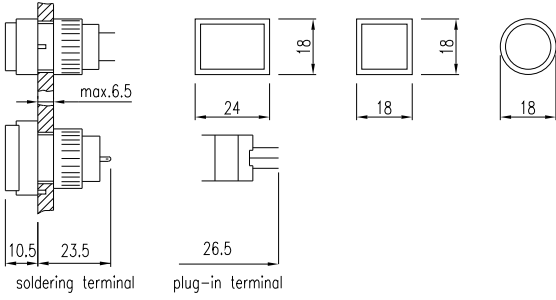

11 Illuminated pushbutton actuator page 7

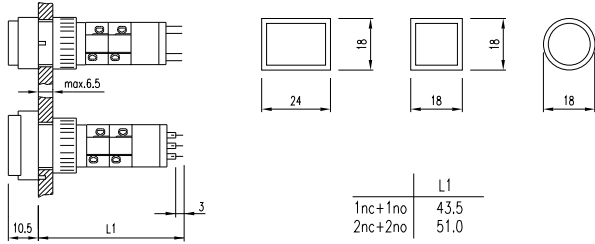

Circuit drawing

1 Buzzer page 6

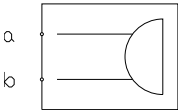

2 Buzzer page 6

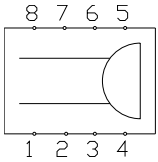

3 Indicator actuator page 6

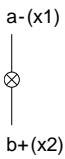

4 Indicator actuator page 6



5 Illuminated pushbutton actuator page 7

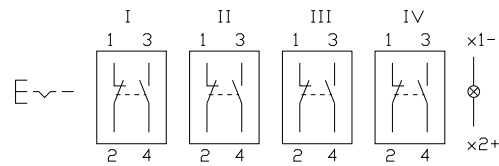

6 Illuminated pushbutton actuator page 7

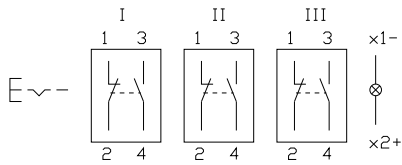

7 Illuminated pushbutton actuator page 7

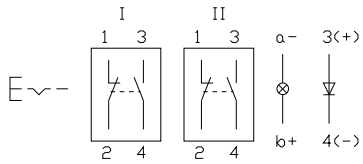

8 Illuminated pushbutton actuator page 7

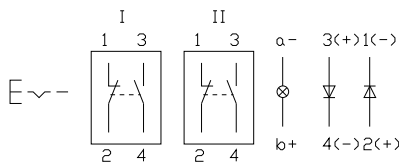

9 Illuminated pushbutton actuator page 7

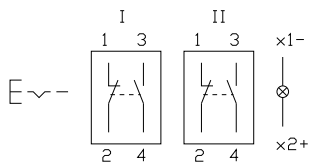

10 Illuminated pushbutton actuator page 7

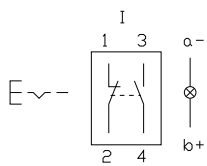

11 Illuminated pushbutton actuator page 7

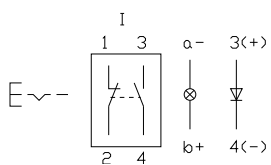

12 Illuminated pushbutton actuator page 7

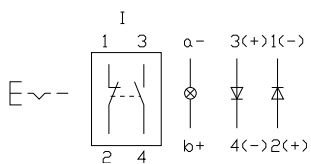

13 Illuminated pushbutton actuator page 7

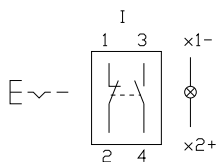

14 Illuminated pushbutton actuator page 7

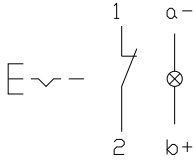

15 Illuminated pushbutton actuator page 7

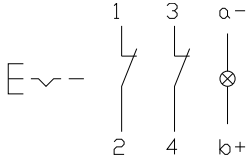

16 Illuminated pushbutton actuator page 7

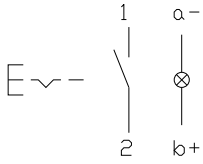

17 Illuminated pushbutton actuator page 7

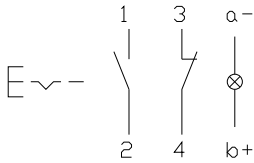

18 Illuminated pushbutton actuator page 7

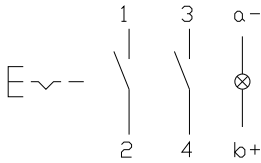

19 Illuminated pushbutton actuator page 7

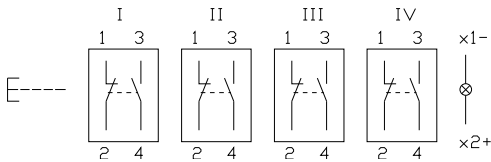

20 Illuminated pushbutton actuator page 7

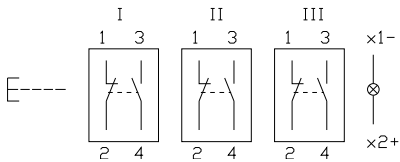

21 Illuminated pushbutton actuator page 7

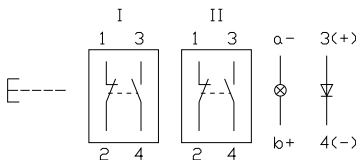

22 Illuminated pushbutton actuator page 7

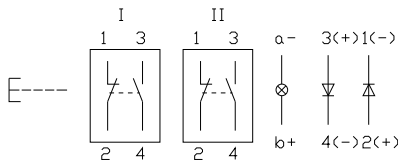

23 Illuminated pushbutton actuator page 7

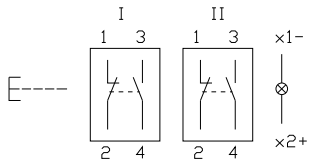

24 Illuminated pushbutton actuator page 7

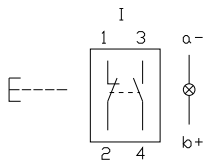

25 Illuminated pushbutton actuator page 7

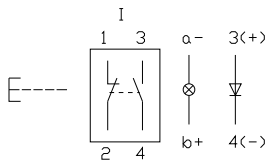

26 Illuminated pushbutton actuator page 7

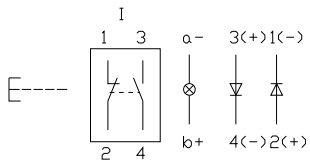

27 Illuminated pushbutton actuator page 7

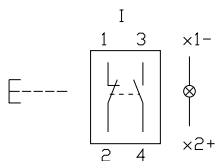

28 Illuminated pushbutton actuator page 7

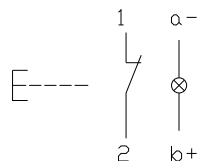

29 Illuminated pushbutton actuator page 7

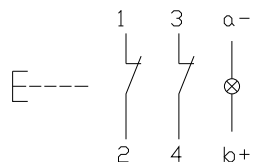

30 Illuminated pushbutton actuator page 7

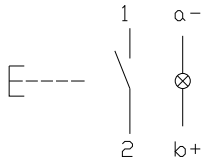

31 Illuminated pushbutton actuator page 7

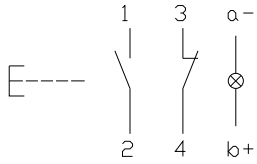

32 Illuminated pushbutton actuator page 7

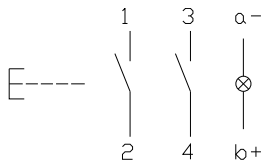

33 Indicator actuator page 6

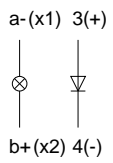

34 Indicator actuator page 6

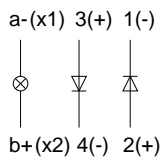

Index from Typ-Nr.

Typ-Nr.	Page	Typ-Nr.	Page	Typ-Nr.	Page
01-906	12	31-121.022	7	31-704.006	6
01-907	12	31-121.0252	7	31-705.0292	7
01-926	9	31-122.0252	7	31-706.0292	7
01-927	9	31-123.0252	7	31-707.0292	7
01-928	10	31-124.0252	7	31-708.0292	7
01-929	10	31-131.022	7	31-709.0292	7
01-947.0	9	31-131.0252	7	31-710.0292	7
01-948.0	9	31-132.0252	7	31-711.0292	7
01-949.0	9	31-133.0252	7	31-712.0292	7
02-904.0	12	31-134.0252	7	31-713.0292	7
02-904.1	12	31-151.022	7	31-714.0292	7
02-904.3	12	31-151.0252	7	31-715.0292	7
02-904.7	12	31-152.0252	7	31-716.0292	7
02-905	12	31-153.0252	7	31-717.0292	7
02-912.1	12	31-154.0252	7	31-718.0292	7
02-912.2	12	31-261.022	7	31-719.0292	7
02-912.3	12	31-261.0252	7	31-720.0292	7
10-1306.1349	11	31-262.0252	7	31-743.0292	7
10-1307.1369	11	31-263.0252	7	31-744.0292	7
10-1309.1309	11	31-264.0252	7	31-745.0292	7
10-1310.1319	11	31-271.022	7	31-746.0292	7
10-1311.1249	11	31-271.0252	7	31-747.0292	7
10-1312.1229	11	31-272.0252	7	31-748.0292	7
10-1313.1209	11	31-273.0252	7	31-749.0292	7
10-1313.1249	11	31-274.0252	7	31-750.0292	7
10-1316.1179	11	31-281.022	7	31-801.002	6
10-1316.1209	11	31-281.0252	7	31-810.005	6
10-1319.1179	11	31-282.0252	7	31-901.0	8
10-1319.1199	11	31-283.0252	7	31-901.2	8
10-2J06.3142	11	31-284.0252	7	31-901.3	8
10-2J06.3144	11	31-421.036	7	31-901.4	8
10-2J06.3145	11	31-422.036	7	31-901.5	8
10-2J06.3146	11	31-423.036	7	31-901.6	8
10-2J06.3149	11	31-425.036	7	31-901.8	8
10-2J09.1062	11	31-426.036	7	31-901.9	8
10-2J09.1064	11	31-431.036	7	31-902.0	8
10-2J09.1065	11	31-432.036	7	31-902.8	8
10-2J09.1066	11	31-433.036	7	31-902.8	8
10-2J09.1069	11	31-435.036	7	31-903.1	8
10-2J12.1062	11	31-436.036	7	31-903.2	8
10-2J12.1064	11	31-451.036	7	31-903.3	8
10-2J12.1065	11	31-452.036	7	31-903.4	8
10-2J12.1066	11	31-453.036	7	31-903.5	8
10-2J12.1069	11	31-455.036	7	31-903.6	8
10-2J13.1062	11	31-456.036	7	31-903.7	8
10-2J13.1064	11	31-461.036	7	31-904.2	8
10-2J13.1065	11	31-462.036	7	31-904.3	8
10-2J13.1066	11	31-463.036	7	31-904.4	8
10-2J13.1069	11	31-465.036	7	31-904.5	8
10-2J19.1042	11	31-466.036	7	31-904.6	8
10-2J19.1044	11	31-471.036	7	31-904.7	8
10-2J19.1045	11	31-472.036	7	31-905.2	8
10-2J19.1046	11	31-473.036	7	31-905.4	8
10-2J19.1049	11	31-475.036	7	31-905.5	8
31-030.002	6	31-476.036	7	31-905.7	8
31-030.005	6	31-481.036	7	31-920	8
31-031.006	6	31-482.036	7	31-923	9
31-040.002	6	31-483.036	7	31-924.2	9
31-040.005	6	31-485.036	7	31-925	8
31-041.006	6	31-486.036	7	31-928	10
31-050.002	6	31-701.006	6	31-929	10
31-050.005	6	31-702.006	6	31-931.0	8
31-051.006	6	31-703.006	6	31-931.2	8

Index from Typ-Nr.

Typ-Nr.	Page	Typ-Nr.	Page	Typ-Nr.	Page
31-931.3	8				
31-931.4	8				
31-931.5	8				
31-931.6	8				
31-931.8	8				
31-931.9	8				
31-933.1	8				
31-933.2	8				
31-933.3	8				
31-933.4	8				
31-933.5	8				
31-933.6	8				
31-933.7	8				
31-935.2	8				
31-935.4	8				
31-935.5	8				
31-935.7	8				
31-940	10				
31-941	10				
31-942	10				
31-945	10				
31-946	10				
31-951.0	8				
31-951.2	8				
31-951.3	8				
31-951.4	8				
31-951.5	8				
31-951.6	8				
31-951.8	8				
31-951.9	8				
31-952.0	8				
31-953.1	8				
31-953.2	8				
31-953.3	8				
31-953.4	8				
31-953.5	8				
31-953.6	8				
31-953.7	8				
31-954.2	8				
31-954.3	8				
31-954.4	8				
31-954.5	8				
31-954.6	8				
31-954.7	8				
31-955.2	8				
31-955.4	8				
31-955.5	8				
31-955.7	8				
61-9740.0	12				

	EAO AG Tannwaldstrasse 88 4601 Olten, Switzerland
E-mail	info@eao.com
Website	www.eao.com
	Austria
Phone	+49/201 85 87 0
E-mail	sales.ede@eao.com
	Belgium
Phone	+32/2 456 00 10
E-mail	sales.ebl@eao.com
	China
Phone	+852/27 86 91 41
E-mail	sales.ehk@eao.com
	France
Phone	+33/1 64 43 37 37
E-mail	sales.es@eao.com
	Germany
Phone	+49/201 85 87 0
E-mail	sales.ede@eao.com
	Italy
Phone	+39/035 481 0189
E-mail	sales.eit@eao.com
	Japan
Phone	+81/3 5401 0953
E-mail	sales.esj@eao.com
	Netherlands
Phone	+31/78 653 17 00
E-mail	sales.enl@eao.com
	Sweden
Phone	+46/8 683 86 60
E-mail	sales.esw@eao.com
	Switzerland
Phone	+41/62 388 95 00
E-mail	sales.ech@eao.com
	United Kingdom
Phone	+44/1444 236000
E-mail	sales.euk@eao.com
	USA
Phone	+1/203 877 4577
E-mail	sales.eus@eao.com
	Other Countries
Fax	+41/62 296 21 62
E-mail	info@eao.com
Website	www.eao.com